

Byggsøk XML 1.0 and Byggsøk XML 1.2

The differences between the two versions

Note no

DART/07/10

Authors

Arne-Kristian Groven

Date

30. September 2010

About the authors

Arne-Kristian Groven is a Senior Research Scientist at Norsk Regnesentral (NR). One of his areas of research is the area of semantic structures.

Norsk Regnesentral

Norsk Regnesentral (Norwegian Computing Center, NR) is a private, independent, non-profit foundation established in 1952. NR carries out contract research and development projects in the areas of information and communication technology and applied statistical modelling. The clients are a broad range of industrial, commercial and public service organizations in the national as well as the international market. Our scientific and technical capabilities are further developed in co-operation with The Research Council of Norway and key customers. The results of our projects may take the form of reports, software, prototypes, and short courses. A proof of the confidence and appreciation our clients have for us is given by the fact that most of our new contracts are signed with previous customers.

Statens Bygningstekniske Etat

Statens Bygningstekniske Etat.

Which is the National Office of Building Technology and Administration in Norway.

Title	Byggsøk XML 1.0 and Byggsøk XML 1.2- The differences between the two versions
Authors	Arne-Kristian Groven (Norsk Regnesentral)
Quality assurance	Thor Kristoffersen (Norsk Regnesentral)
Date	30. September
Year	2010
Publication number	DART/07/10

Abstract

This note describes the differences between Byggsøk XML, version 1.0, and the currently (August 2010) running version, Byggsøk XML, version 1.2.

The document aims at giving a full coverage of the differences between the two versions.

Keywords	XML, XML Schemas, Metadata Structures
Target group	Statens bygningstekniske etat and their associates
Availability	Public
Project number	320371
Research field	
Number of pages	17
© Copyright	Norsk Regnesentral

Contents

1	Introduction	7
2	Byggesak	8
3	Byggesaksprosess	9
4	Tiltaketsart	9
5	Part	10
6	Adresse	10
7	Kontaktinformasjon	11
8	Rolle	11
9	Eiendom	12
10	Bygning	13
11	Ansvar og kontroll	14
	11.1 Kontrollerklæring	14
	11.2 Kontrollplan	15
	11.3 Lokal godkjenning	15
12	Tiltaketsramme	17
	12.1 Bruk	17
	12.2 Bebyggelse	17
	12.3 Avstander	17
	12.4 Grunn- og miljøforhold	17
	12.5 Infrastruktur	17
	12.6 Plan	17
13	Arbeidstilsynet	17
14	GAB registrering	17
15	Vedlegg, kommentarer and any	17

List of figures

Figure 1 The byggsak XML structure in version 1.2.....	8
Figure 2 The part XML structure in version 1.2.....	10
Figure 3 The enkelAdresseType XML structure in version 1.2.....	11
Figure 4 The rolle XML structure in version 1.2.....	12
Figure 5 The eiendom XML structure in version 1.2.....	13
Figure 6 The ansvarogkontroll XML structure in version 1.2.....	14
Figure 7 The kontrollerklering XML structure in version 1.2.....	14
Figure 8 The kontrollplan XML structure in version 1.2.....	16

1 Introduction

This document describes the differences between Byggsøk XML, version 1.0, and the currently running version, Byggsøk XML, version 1.2.

Byggsøk version 1.0 was documented by Per Thomas Jahr in a document having the publication date: 28.th February 2003. It is written in Norwegian and the title is “Dokumentasjon av XML strukturer for Byggsøk”.

The current document aims at giving a full coverage of the differences between the two versions.

One general difference between the versions is that everything is made optional in version 1.2.

The structure of the documentation of Byggsøk XML, version 1.0, is kept.

2 Byggesak

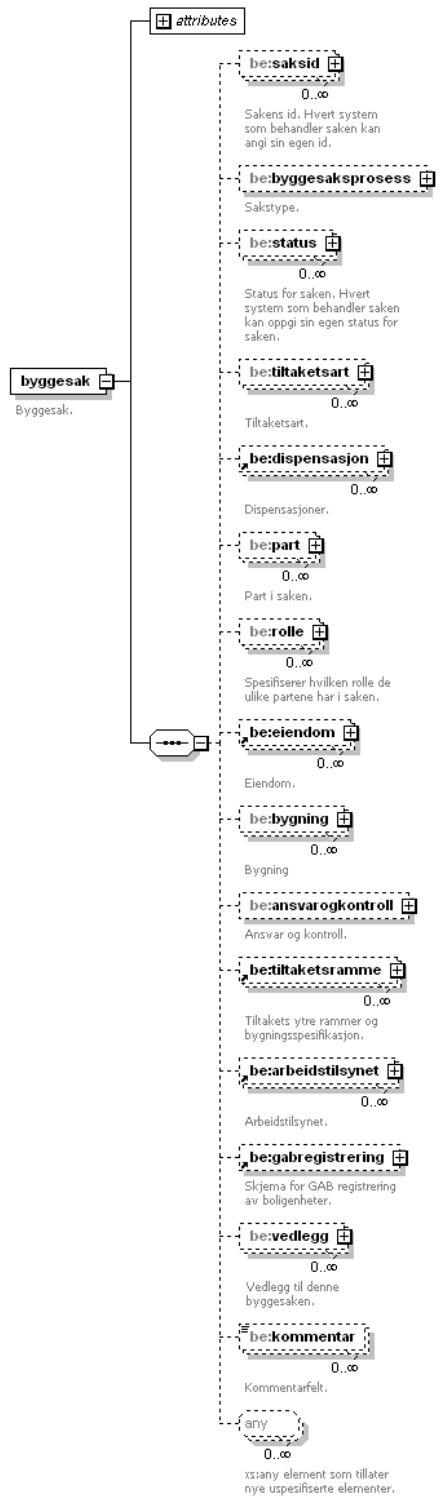

Figure 1 The byggesak XML structure in version 1.2

The difference between the two versions is as follows:

- The element “be: dispensasjon” is included in version 1.2.

3 Byggesaksprosess

No changes.

4 Tiltaketsart

The difference between the two versions is as follows:

- The element “be: erestetikkrelevant” is included.
- New value options have been introduced: 204, 404-409, 950, 990-993

5 Part

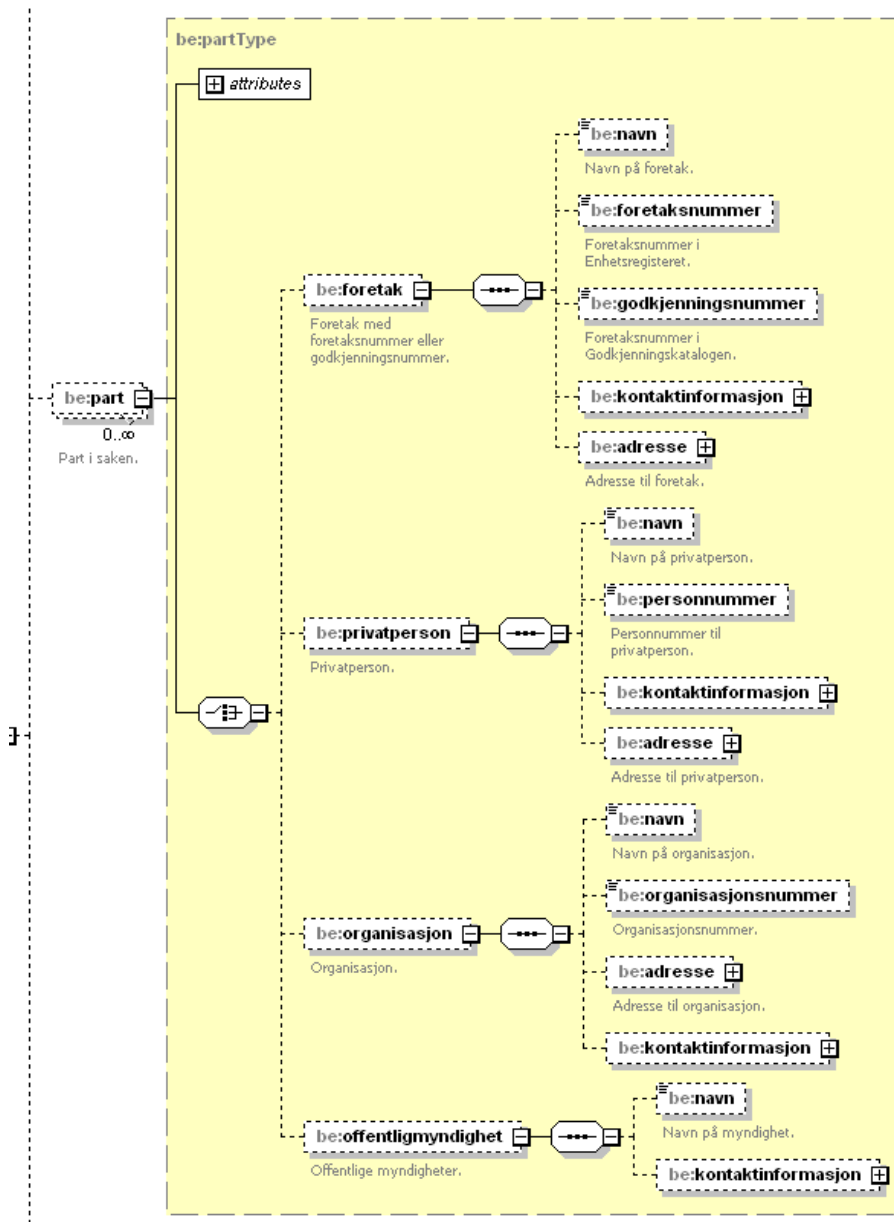

Figure 2 The part XML structure in version 1.2

The difference between the two versions is as follows:

- In “be:privatperson”, the element “be: personnummer” is included in version 1.2

6 Adresse

The difference between the two versions is as follows:

- Some changes under “be:adresselinje”, in version 1.2. But this is of syntactical nature.

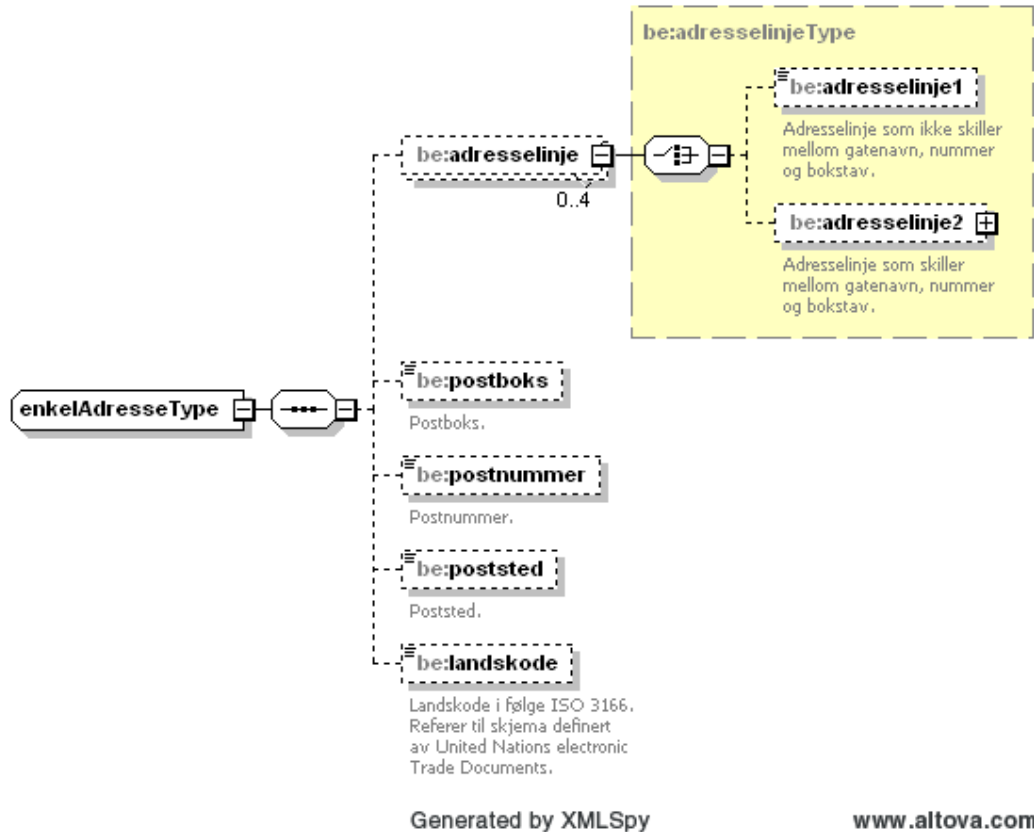

Figure 3 The enkelAdresseType XML structure in version 1.2

7 Kontaktinformasjon

No changes. (“kontaktinformasjon” lies under “part”.)

8 Rolle

The difference between the two versions is as follows:

- Some changes under “be:rolle”, in version 1.2.

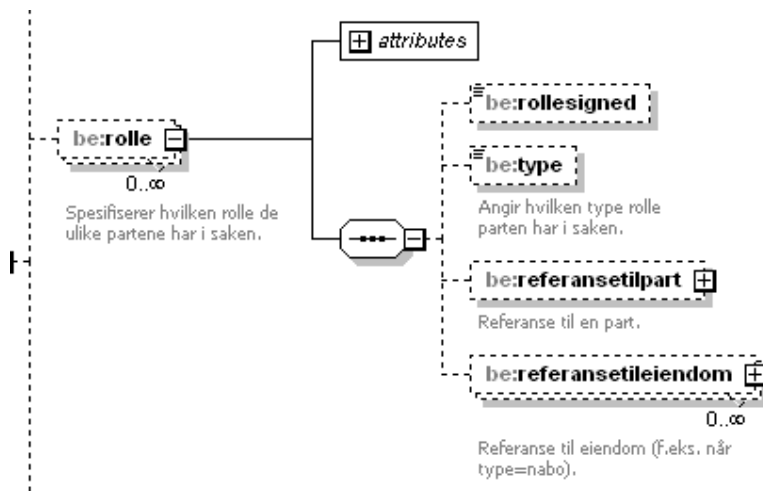
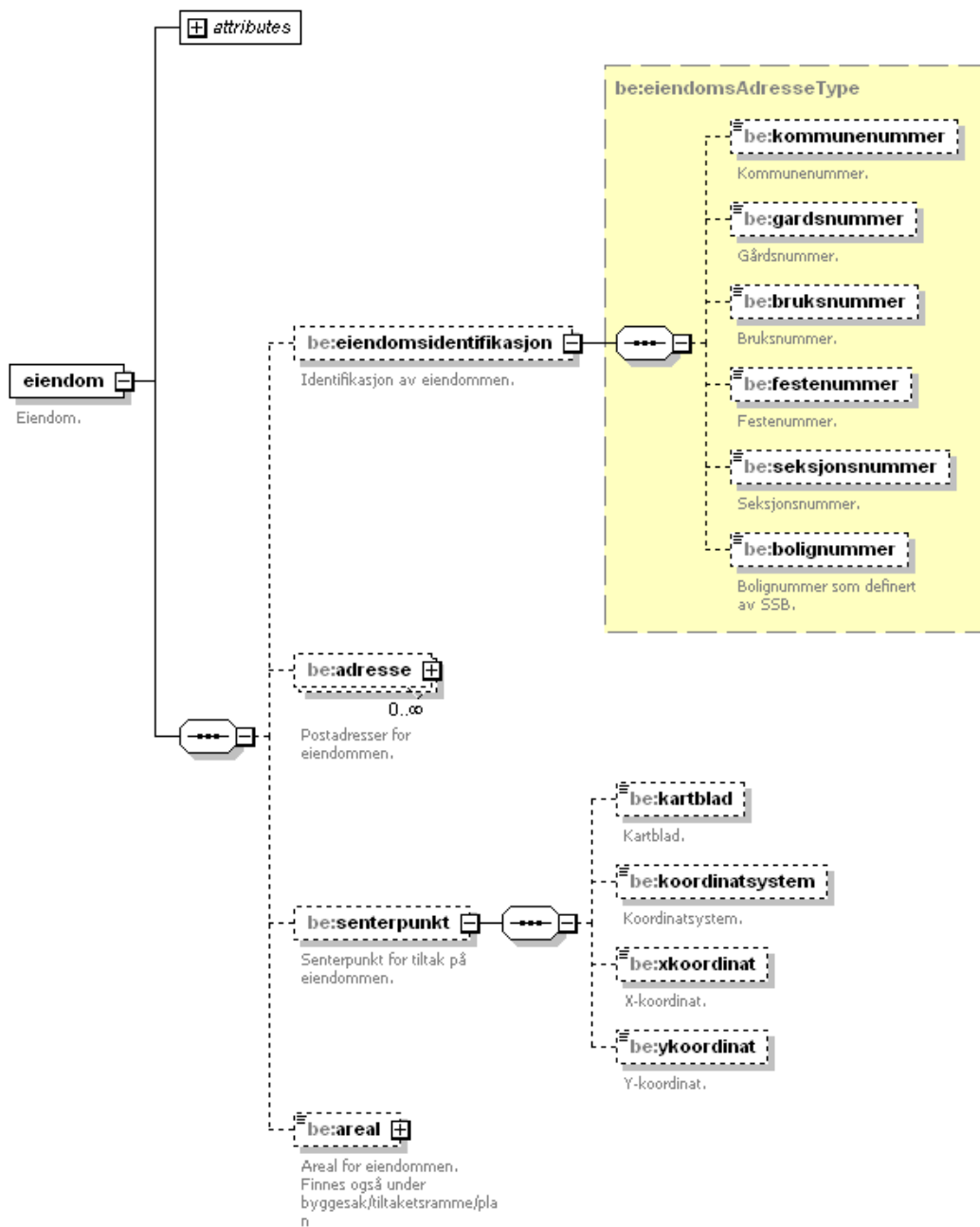

Figure 4 The rolle XML structure in version 1.2

9 Eiendom

The difference between the two versions is as follows:

- Attributes included, both under "eiendom" and "areal"
- In "be:eiendomsidentifikasjon" of type "be:eiendomsAdresseType, the element "be:bolignummer" is included in version 1.2.



Generated by XMLSpy

www.altova.com

Figure 5 The eiendom XML structure in version 1.2

10 Bygning

New attribute under "referanseeiendom".

11 Ansvar og kontroll

The difference between the two versions is as follows:

- The element "be: godkjenningsomrade" is included in version 1.2.

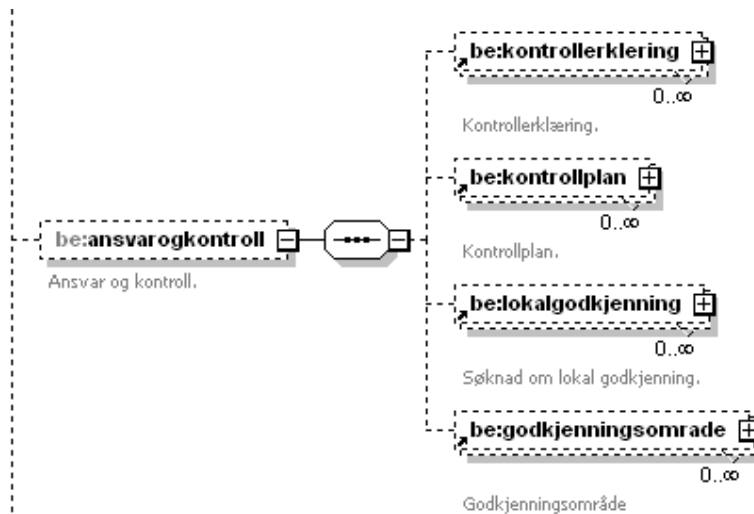

Figure 6 The ansvarogkontroll XML structure in version 1.2

11.1 Kontrollerklæring

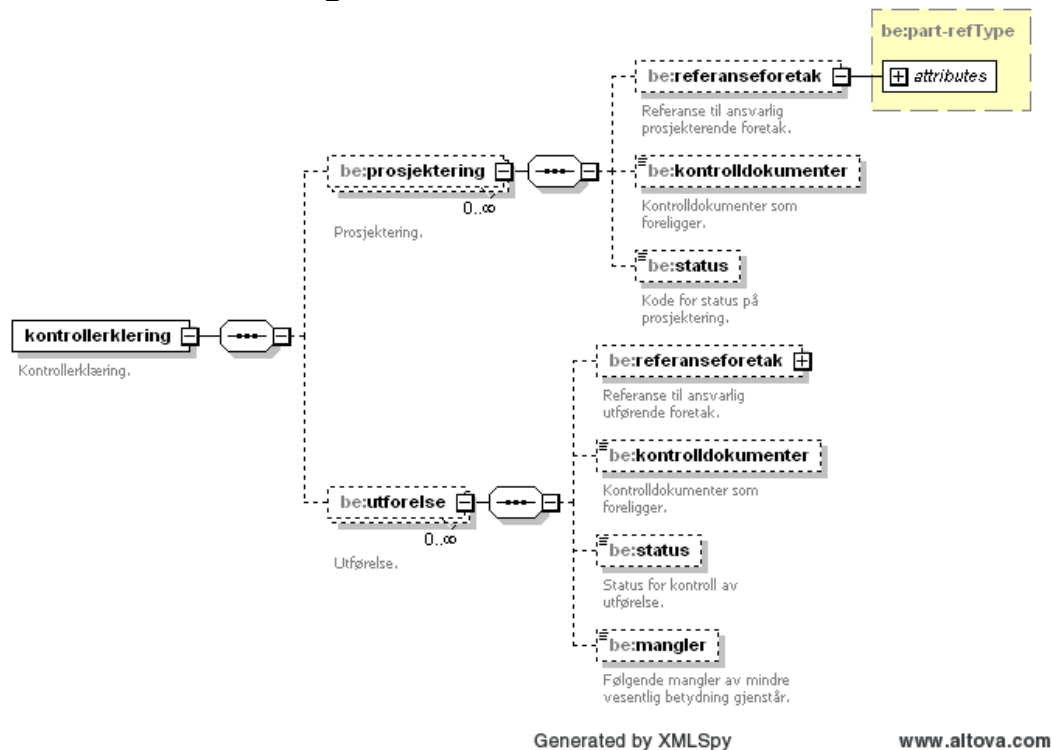

Figure 7 The kontrollerklæring XML structure in version 1.2

The difference between the two versions is as follows:

- In “be:referanseforetak”, “be: part-refType” is included in version 1.2, both under “prosjektering” and under “utforelse”.

11.2 Kontrollplan

The difference between the two versions is as follows:

- In “be:prosjektering”, everything preceding “fagområde” in Figure 8 is new in version 1.2.
- In “be:utforelse”, “everything preceding “fagområde” in Figure 8 is new in version 1.2.

11.3 Lokal godkjenning

No changes¹.

¹ But details in “utdanningsniva” can not be read in the documentation of version 1.0.

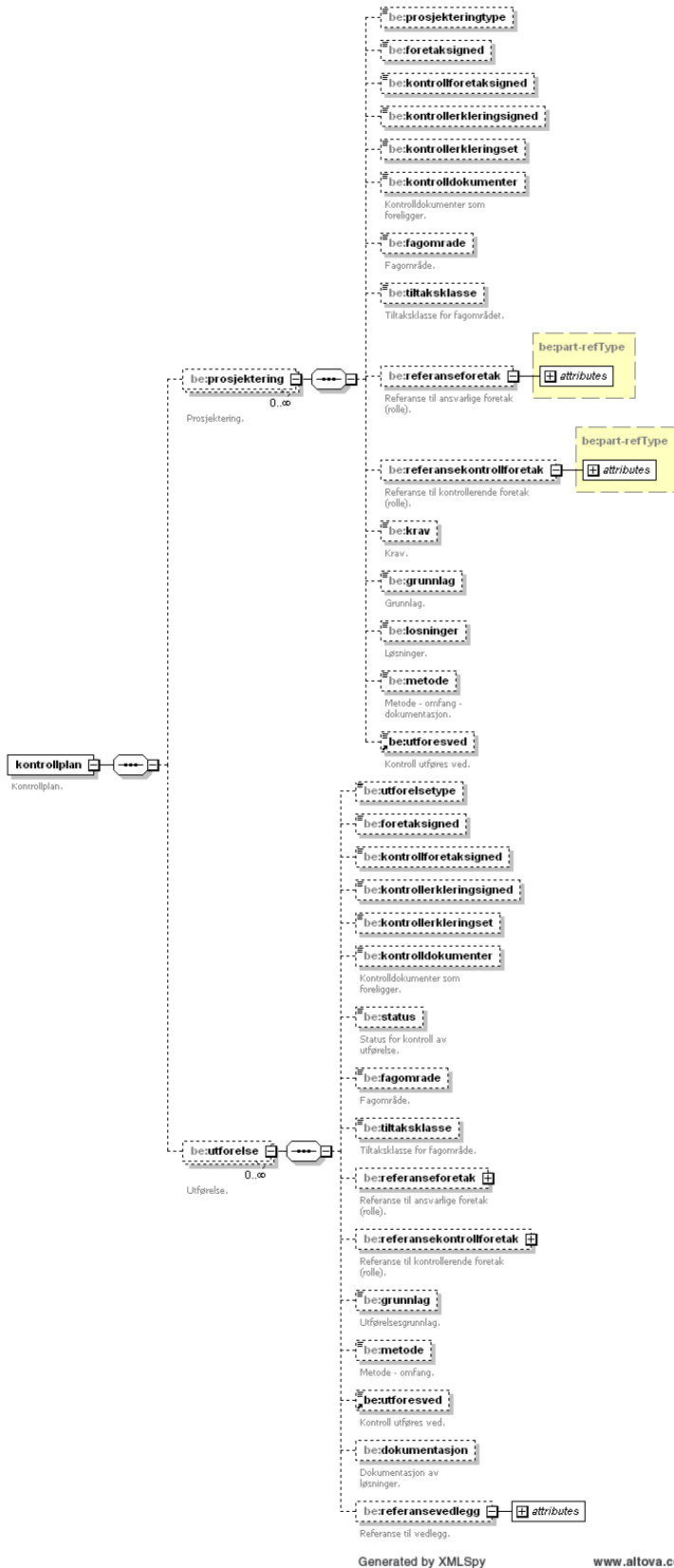

Figure 8 The kontrollplan XML structure in version 1.2

12 Tiltaketsramme

The element “be:varsling” and its sub-structures are new elements under “be:tiltaksramme”.

12.1 Bruk

No changes.

12.2 Bebyggelse

The difference between the two versions is as follows:

- “be:bruksarealannet” included in version 1.2.

12.3 Avstander

The difference between the two versions is as follows:

- New attributes of type “be:lengde” are include for “be:annetbygg”, “be: nabogrense”, “be:vegmidte”, “be:kabel”, and “be:vannogavløp” in version 1.2.

12.4 Grunn- og miljøforhold

The difference between the two versions is as follows:

- “be:grunnforholdvedlegg” with an attribute reference included in version 1.2.
- “be:rasfareellerflomvedlegg ” with an attribute reference included in version 1.2.
- “be:miljoforholdvedlegg” with an attribute reference included in version 1.2.

12.5 Infrastruktur

No changes.

12.6 Plan

No changes.

13 Arbeidstilsynet

No changes, except for the fact that “be:referansepart” has changed slightly.

14 GAB registrering

No changes.

15 Vedlegg, kommentarer and any

Id attribute included in “be:vedlegg”.